

1M-P04s



Dostępne warianty



EN

Technical data

Device size	7,45 x 2,35 m
Device height	2,00 m
Impact area dimensions	10,79 x 5,69 m
Impact area	56,39 m ²
Free fall height (HIC)	2,00 m
Maximum user's weight	120 kg
Users group	users starting from 8 years of age, having the skills of practicing parkour
Norm	PN-EN 16899:2017-02
Manufacturing country	Poland

Material specification

Construction	profile 40x40 mm, galvanized pipes 88,9 mm powder coated
Others	pipes 42,4 mm, galvanized
Connections	galvanized steel
Others	anti-slip plywood th.18 mm
Standard colors	construction poles RAL 9005 walls construction galvanized plywood grey / black / with graphic
Impact attenuating surface	according to PN-EN 1177+AC:2019-04

Device and impact area dimensions

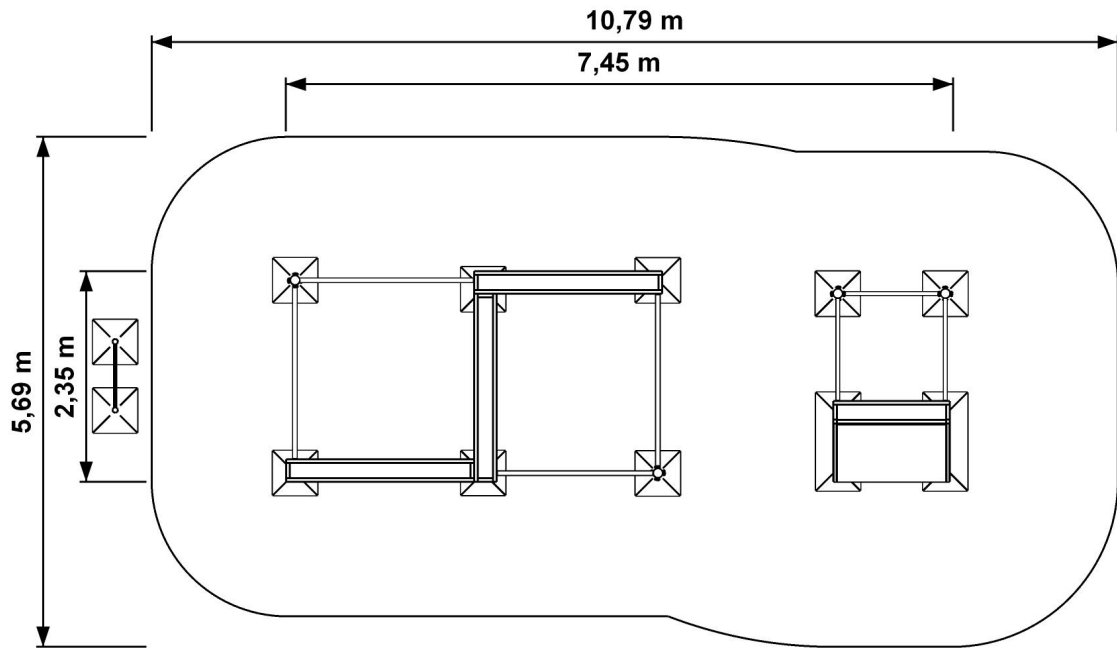

Methods of installation

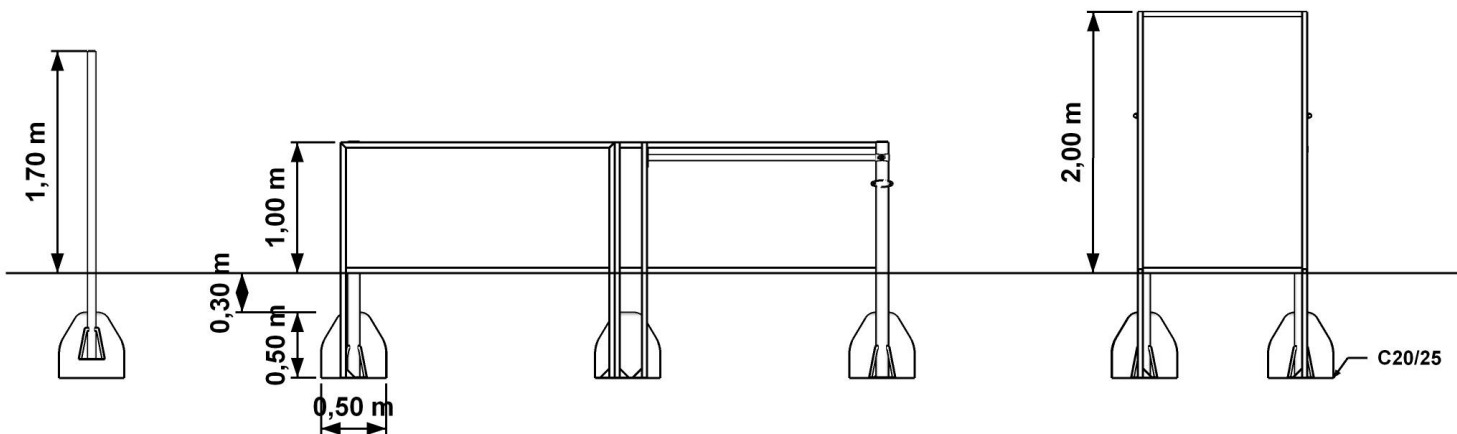

Devices permanently anchored on foundation made of semi-dry concrete C20/25, 80 cm below ground level. Min. dimensions of foundation 50x50x50 cm.



Maintenance manual

Routine inspection:

Visual inspection device is intended to detect visible damage and risks that could arise for reasons such as: misuse, vandalism or weather conditions. Inspection frequency - 1/week. First inspection before first using:

Protect equipment from use and remove assembly aids until commissioning. Check the tightness of the connections, especially the foundation screws.

NOTE 1 For outdoor fitness installed in areas with intensive use of equipment, and also in areas characterized to frequent damage caused by vandalism, may be required daily inspection.

NOTE 2 During the inspection routine and operational should pay attention to: cleanliness, level ground state of the ground, exposed (mobile) foundations, sharp edges, missing parts, excessive used (mobile and disperse the parts), structural strength of construction.

Operational control:

More accurate than a routine inspection of facilities for checking the functionality and stability of exercise equipment. You should do this every 1 to 3 months according to guidance of manufacturer.

Main annual inspection:

Control of defining the overall condition for safe exploiting of equipment (main annual review).

NOTE 3 Main annual inspection may need to dig or decompose (spin) of individual equipment or their parts.

The annual inspection should be performed by the manufacturer or an authorized repairer Outdoor Fitness Center. Submissions annual inspection the following address: fitness@outdoorfitness.pl

Failures

In the absence of damage or exploiting of the device must be immediately replaced or repaired. If this is not possible, secure the unit before use. Contact the site Outdoor Fitness Center: fitness@outdoorfitness.pl. Use only original spare parts. Repair and replacement of parts may only make the manufacturer or its authorized representative.